

Bühler Chain Catalog.

Quality from Bühler.

For the markets of Europe and Middle East
RFKG, LBCA, and MNKA



Bühler conveyor chains.

A chain is as strong as
its weakest link.

Conveyors are the backbone of any plant. Reliable conveying systems are a prerequisite for transforming a processing plant into a smoothly functioning and thus economic overall unit.

One important function within a conveying system is fulfilled by the chain conveyor. Its heart is the conveyor chain, whose specific characteristics will vary with its particular application.

Bühler has accumulated vast experience in the development and manufacture of conveyor chains. Over the decades, this has produced a wide variety of design versions and options. The available chain solutions range from Standard and Sanitation to Heavy-Duty applications and thus cover the most diverse and all but limitless customer needs.

**Sprocket chain
(Standard)**



**Round-link chain
(Sanitation)**



**Fork chain
(Heavy-Duty)**



- Optimal for harvest operations plus grain handling and processing
- Excellent price-to-performance ratio with moderate operating times
- Used in grain and feed mills or other processing plants
- Optimal chain with food-grade plastic chain flights (FDA) running directly on the casing bottom for minimum product residues in the casing
- Used in bulk storage and port terminal installations with large materials handling volumes
- Forged and hardened fork chain with high wear resistance and tensile strength guarantees long lifecycle under extreme conditions

Bühler fork chains.

Perfect, from link to link.

You receive high quality and thus added value thanks to our modern and certified manufacturing process. Don't hesitate to benefit from our vast experience in the production of conveyor chains.



Drop-forging

Drop-forging of links produces a finer structure of the material and a high tensile strength.



Link machining

High-precision machining of the fork head and bore produce a consistent geometry and dimensional accuracy. This ensures smooth, effortless, and low-wear running of the chain.



Surface hardening

Thermal treatment for hardening each chain link is carried out on state-of-the-art facilities and ensures a consistent surface hardness and depth of hardness.



Robot welding system

High-strength and crack-free welded joints between the fork head and the flights are achieved by an advanced robot welding system.









Quality inspection

As an ISO-certified company, we inspect the links along the entire production process and document the manufacturing steps.









Fork chains.

Conveyor chain strands.

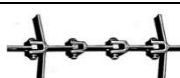
Chain type	Chain link	Object	Cleaner flight width [mm]	Weight [kg]	Article number
RFKG-100					
102V		Conveyor chain T1 L=2.036m	303	20.3	RFKG-80244-810
		Conveyor chain T1 pin and washer stainless L=2.036m	303	20.3	RFKG-82084-810
		Conveyor chain T1 for lateral wear plates L=2.036m	283	19.4	RFKG-82346-810
102V		Conveyor chain T2 L=2.036m	303	14.3	RFKG-80246-810
		Conveyor chain T2 pin and washer stainless L=2.036m	303	14.3	RFKG-82082-810
		Conveyor chain T2 for lateral wear plates L=2.036m	283	13.4	RFKG-82120-810
102V		Conveyor chain T3 L=2.036m	303	12.5	RFKG-80247-810
		Conveyor chain T3 pin and washer stainless L=2.036m	303	12.5	RFKG-82085-810
RFKG-200					
102V		Conveyor chain T1 L=2.036m	388	26.2	RFKG-83055-810
		Conveyor chain T1 pin and washer stainless L=2.036m	388	26.2	RFKG-82097-810
		Conveyor chain T1 for lateral wear plates L=2.036m	368	25.3	RFKG-82342-810
102V		Conveyor chain T2 L=2.036m	388	18.3	RFKG-83056-810
		Conveyor chain T2 pin and washer stainless L=2.036m	388	18.3	RFKG-82098-810
		Conveyor chain T2 for lateral wear plates L=2.036m	368	17.4	RFKG-82343-810
102V		Conveyor chain T3 L=2.036m	388	15.9	RFKG-83057-810
		Conveyor chain T3 pin and washer stainless L=2.036m	388	15.9	RFKG-82099-810
		Conveyor chain T3 for lateral wear plates L=2.036m	368	15.0	RFKG-13084-001







Fork chains.

Conveyor chain strand.

Chain type	Chain link	Object	Cleaner flight width [mm]	Weight [kg]	Article number
RFKG-400Z					
142Z		Conveyor chain T1 standard version and for wear protection plates L=1.988m	476	43.0	RFKG-83027-810
142Z		Conveyor chain T2 standard version and for wear protection plates L=1.988m	476	35.0	RFKG-83028-810
142Z		Conveyor chain T3 standard version and for wear protection plates L=1.988m	476	27.0	RFKG-83029-810
RFKG-400V					
142V		Conveyor chain T1 standard version and for wear protection plates L=1.988m	476	50.0	RFKG-83037-810
142V		Conveyor chain T2 standard version and for wear protection plates L=1.988m	476	40.4	RFKG-83038-810
142V		Conveyor chain T3 standard version and for wear protection plates L=1.988m	476	37.4	RFKG-83039-810
RFKG-600					
142V		Conveyor chain T1 standard version and for wear protection plates L=1.988m	626	64.5	RFKG-80533-810
142V		Conveyor chain T2 standard version and for wear protection plates L=1.988m	626	45.5	RFKG-80534-810
142V		Conveyor chain T3 standard version and for wear protection plates L=1.988m	626	40.0	RFKG-80536-810

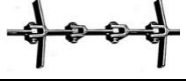
Fork chains.

Conveyor chain strand.

Chain type	Chain link	Object	Cleaner flight width [mm]	Weight [kg]	Article number
RFKG-800					
142V		Conveyor chain T1 standard version and for wear protection plates L=1.988m	776	86.2	RFKG-80876-810
142V		Conveyor chain T2 standard version and for wear protection plates L=1.988m	776	56.3	RFKG-80884-810
142V		Conveyor chain T3 standard version and for wear protection plates L=1.988m	776	47.8	RFKG-80885-810
RFKG-1000					
142V		Conveyor chain T1 standard version and for wear protection plates L=1.988m	968	126.0	RFKG-81452-810
142V		Conveyor chain T2 standard version and for wear protection plates L=1.988m	968	76.2	RFKG-81453-810
142V		Conveyor chain T3 standard version and for wear protection plates L=1.988m	968	62.0	RFKG-81454-810

Fork chains.

Chain link.

Chain type	Longitudinal link	Weight [kg]	Article number
102V		0.4	RNG-20015-010
142Z		1.1	RNG-20017-010
142V		1.7	RNG-20019-010
260Z*		5.0	RNG-20021-010

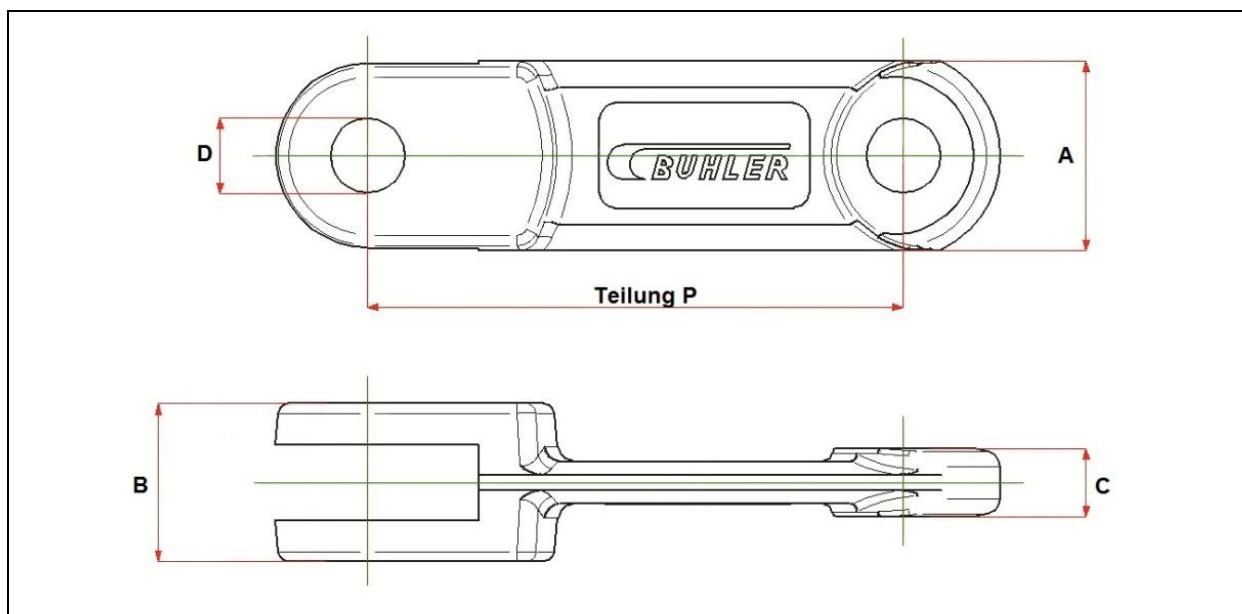







Chain type	Pitch P [mm]	A [mm]	B [mm]	C [mm]	D [mm]	Allowable tensile force [kN]
102V	102	36	28	12	14	25
142Z	142	50	42	19	25	50
142V	142	50	62	28	25	80
260Z	260	75	70	28	32	120

*Chain strands of type 260Z available upon request









Fork chains.

Chain link and cleaner flight link.

Chain type	Chain link	Object	Cleaner flight width [mm]	Weight [kg]	Article number
RFKG-100					
102V		Chain link 35/8 standard	303	1.0	RFKG-80240-810
		Cleaner flight link 35/8 standard	303	1.0	RFKG-80241-810
		Chain link for lateral wear plates	283	1.0	RFKG-82109-810
		Cleaner flight link for lateral wear plates	283	1.0	RFKG-82110-810
		Plastic cleaner flight pair standard	137	0.1	RFKG-80248-810
		Plastic cleaner flight pair for lateral plastic plates	126	0.1	RFKG-82111-810
		Plastic cleaner flight pair for lateral wear plates	131	0.1	RFKG-82345-810
RFKG-200					
102V		Chain link 35/8 standard	388	1.2	RFKG-83049-810
		Cleaner flight link 35/8 standard	388	1.2	RFKG-83053-810
		Chain link 35/8 for lateral wear plates	368	1.1	RFKG-82341-810
		Cleaner flight link 35/8 for lateral wear plates	368	1.1	RFKG-82338-810
		Plastic cleaner flight pair standard	179	0.1	RFKG-83054-810
		Plastic cleaner flight pair for lateral plastic plates	169	0.1	RFKG-82339-810
		Plastic cleaner flight pair for lateral wear plates	174	0.1	RFKG-82340-810
RFKG-400Z					
142Z		Chain link 50/10	476	2.8	RFKG-83020-810
		Cleaner flight link 50/10	476	2.8	RFKG-83021-810
		Plastic cleaner flight pair standard	220	0.2	RFKG-83022-810
		Plastic cleaner flight pair for lateral wear plates	214	0.2	RFKG-82259-810

Fork chains.

Chain link and cleaner flight link.

Chain type	Chain link	Object	Cleaner flight width [mm]	Weight [kg]	Article number
RFKG-400V					
142V		Chain link 50/10	476	3.1	RFKG-83036-810
		Cleaner flight link 50/10	476	3.1	RFKG-83041-810
		Plastic cleaner flight pair standard	214	0.2	RFKG-83042-810
RFKG-600					
142V		Chain link 50/12	626	4.1	RFKG-80532-810
		Cleaner flight link 50/12	626	4.1	RFKG-80529-810
		Plastic cleaner flight pair standard	289	0.3	RFKG-80684-810
		Plastic cleaner flight pair for lateral wear plates	283	0.3	RFKG-13076-001
RFKG-800					
142V		Chain link 50/15	776	5.8	RFKG-80877-810
		Cleaner flight link 50/15	776	5.8	RFKG-80878-810
		Plastic cleaner flight pair standard	360	0.3	RFKG-80886-810
		Plastic cleaner flight pair for lateral wear plates	354	0.3	RFKG-82261-810
RFKG-1000					
142V		Chain link 50/20	968	8.7	RFKG-81440-810
		Cleaner flight link 50/20	968	8.7	RFKG-81446-810
		Plastic cleaner flight pair standard	460	0.4	RFKG-81447-810
		Plastic cleaner flight pair for lateral wear plates	454	0.4	RFKG-81449-810

The cleaner flight link is already provided with the holes needed for attaching the plastic cleaner flight

Fork chains.

Pin and washer.



Chain type	Object	Weight [kg]	Article number
102V	Pin D=14 with preassembled washer	0.06	RFKG-85047-810
	Pin D=14 with preassembled washer stainless	0.06	RFKG-82083-810
	Washer D=14	0.01	RFKG-50119-010
	Washer stainless D=14	0.01	RFKG-12417-010
142Z	Pin D=25 with preassembled washer	0.26	RFKG-85012-810
	Washer D=25	0.02	RFKG-50054-010
142V	Pin D=25 with preassembled washer	0.3	RFKG-85029-810
	Washer D=25	0.02	RFKG-50054-010
260Z	Pin D=32 with preassembled washer	0.64	RNG-84052-980
	Washer D=32	0.06	RNG-50120-010

Fork chains.

Chain sprocket.



Chain type	Number of teeth	Pitch circle diameter [mm]	Weight [kg]	Article number
102V	10 teeth	329.5	14.8	RFKG-80089-810
142Z		459.5	44.2	RFKG-84028-810
142V	11 teeth	504.4	71.0	RFKG-84046-810
102V	12 teeth	394.1	19.8	RFKG-83059-810

Chain sprocket wheel with chain rim: always split, hardened, and bolted

Chain return sprockets.



Chain type	Diameter [mm]	Weight [kg]	Article number
102V	275.5	13.2	RFKG-80261-810
	362	23.0	RFKG-80014-810
142Z	434	49.1	RFKG-84030-810
142V	434	64.0	RFKG-84047-810
	517	92.5	RFKG-80562-810

Scope of supply: Return and intermediate sprocket segments, hexagon bolts, and locknuts

Sprocket chains.

Conveyor chain standard without cleaner flight.

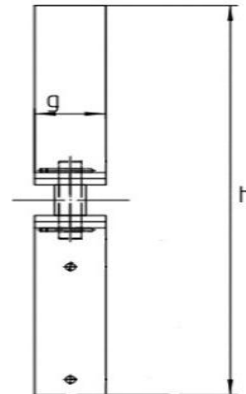
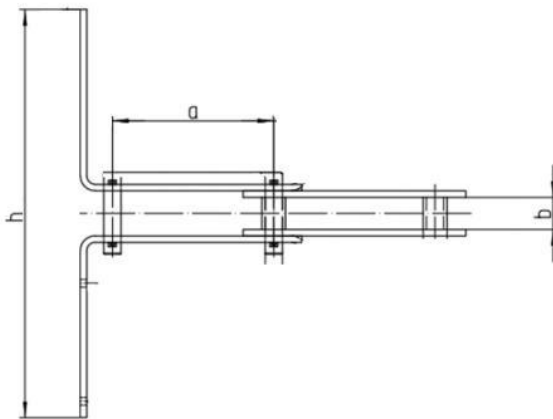

LBCA type	a [mm]	b [mm]	h [mm]	g [mm]	Breaking load [kN]	Weight [kg/m]	Article number
20	125	25	180	35	90	5.1	UVN -70094-003
30	150	30	290	50	112	9.4	UVN -70094-009
30-2	150	45	290	50	180	13.0	UVN -70094-011
40H-1	150	30	380	50	112	10.3	UVN -70094-013
40H-2	150	45	380	50	180	14.0	UVN -70094-025
40H-3	150	55	380	60	250	18.0	UVN -70094-027
50-1	150	30	480	50	112	15.0	UVN -70094-406
50-2	150	45	480	50	180	15.8	UVN -70094-411
50-3	150	55	480	60	250	20.8	UVN -70094-414
50-4	150	70	480	70	400	32.8	UVN -70094-418
60-1	150	30	580	50	112	17.7	UVN -70094-531
60-2	150	45	580	50	180	18.5	UVN -70094-503
60-3	150	55	580	60	250	23.7	UVN -70094-155
60-4	150	70	580	70	400	35.0	UVN -70094-510

Sprocket chains.

Conveyor chain standard with cleaner flight.

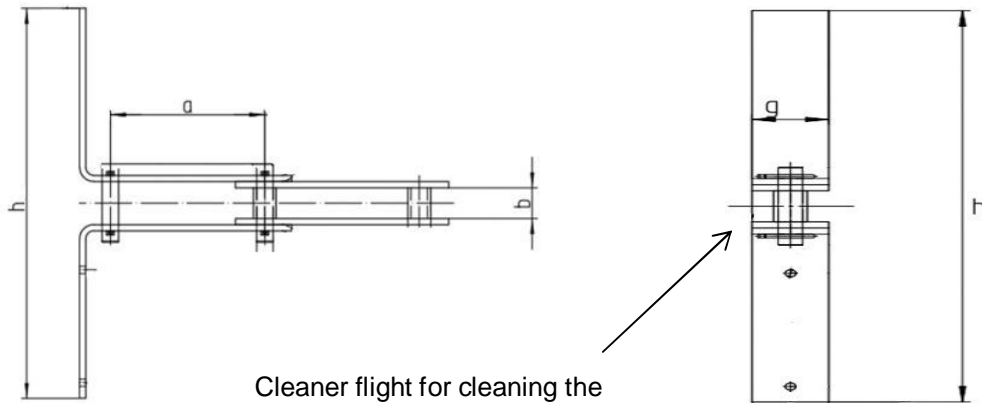

Cleaner flight for cleaning the clearance between the bottom and the pin at 3m intervals

LBCA type	a [mm]	b [mm]	h [mm]	g [mm]	Breaking load [kN]	Weight [kg/m]	Article number
20	125	25	180	35	90	5.1	UVN -70094-103
30	150	30	290	50	112	9.4	UVN -70094-109
30-2	150	45	290	50	180	13.0	UVN -70094-111
40H-1	150	30	380	50	112	10.3	UVN -70094-113
40H-2	150	45	380	50	180	14.0	UVN -70094-115
40H-3	150	55	380	60	250	18.0	UVN -70094-117
50-1	150	30	480	50	112	15.0	UVN -70094-405
50-2	150	45	480	50	180	15.8	UVN -70094-410
60-1	150	30	580	50	112	17.7	UVN -70094-530
60-2	150	45	580	50	180	18.5	UVN -70094-502

Sprocket chains.

High-capacity chain without cleaner flight.

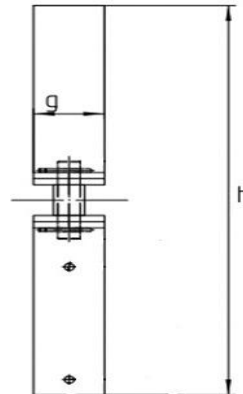
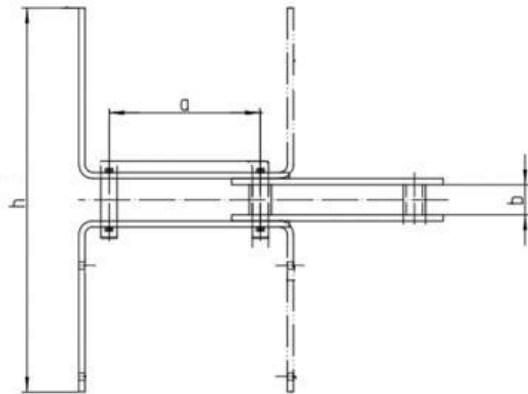

LBCA type	a [mm]	b [mm]	h [mm]	g [mm]	Breaking load [kN]	Weight [kg/m]	Article number
20	125	25	180	35	90	5.6	UVN -70094-004
30	150	30	290	50	112	11.4	UVN -70094-010
30-2	150	45	290	50	180	15.0	UVN -70094-012
40H-1	150	30	380	50	112	12.8	UVN -70094-014
40H-2	150	45	380	50	180	17.0	UVN -70094-026
40H-3	150	55	380	60	250	21.5	UVN -70094-028
50-1	150	30	480	50	112	19.5	UVN -70094-409
50-2	150	45	480	50	180	20.2	UVN -70094-413
50-3	150	55	480	60	250	25.9	UVN -70094-416
60-1	150	30	580	50	112	24.3	UVN -70094-531
60-2	150	45	580	50	180	25.0	UVN -70094-505
60-3	150	55	580	60	250	31.2	UVN -70094-508

Sprocket chains.

High-capacity chain with cleaner flight.

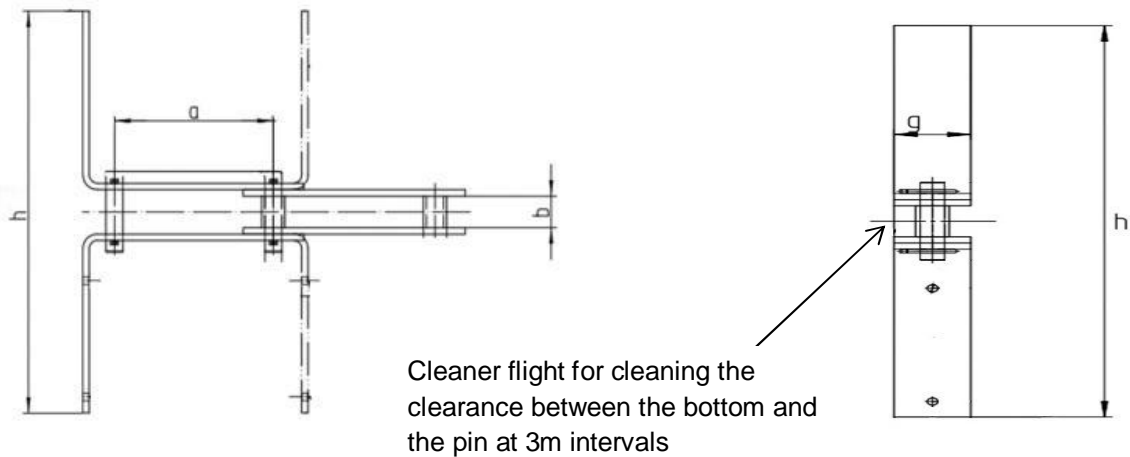

Cleaner flight for cleaning the clearance between the bottom and the pin at 3m intervals

LBCA type	a [mm]	b [mm]	h [mm]	g [mm]	Breaking load [kN]	Weight [kg/m]	Article number
20	125	25	180	35	90	5.6	UVN -70094-104
30	150	30	290	50	112	11.4	UVN -70094-110
30-2	150	45	290	50	180	15.0	UVN -70094-112
40H-1	150	30	380	50	112	12.8	UVN -70094-114
40H-2	150	45	380	50	180	17.0	UVN -70094-116
40H-3	150	55	380	60	250	21.5	UVN -70094-118
50-1	150	30	480	50	112	19.5	UVN -70094-408
50-2	150	45	480	50	180	20.2	UVN -70094-412
60-1	150	30	580	50	112	24.3	UVN -70094-152
60-2	150	45	580	50	180	25.0	UVN -70094-504

Sprocket chains.

Reversible chain without cleaner flight.

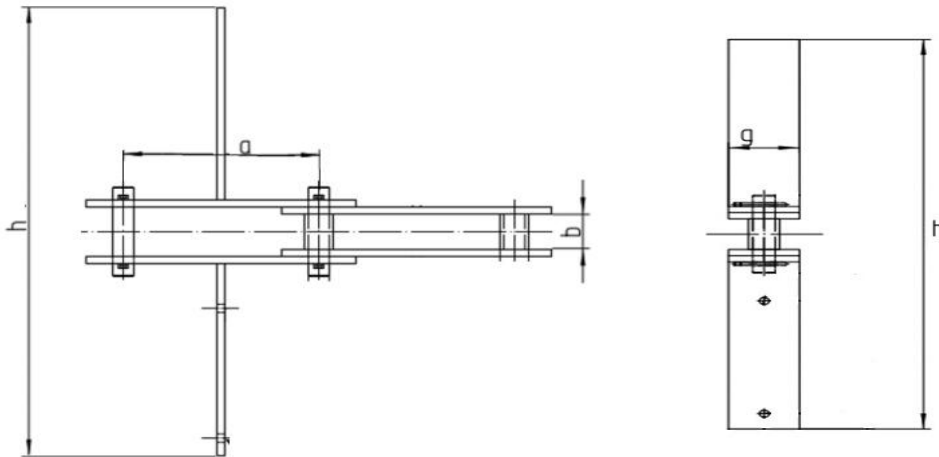
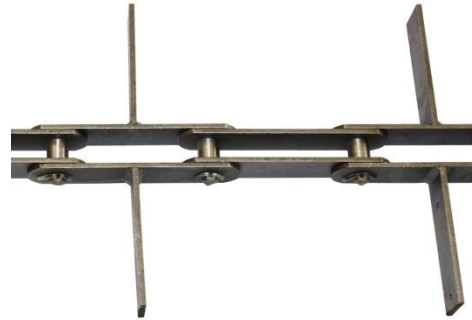

LBCA type	a [mm]	b [mm]	h [mm]	g [mm]	Breaking load [kN]	Weight [kg/m]	Article number
20	125	25	180	35	90	5.1	UVN -70094-203
30	150	30	290	50	112	9.4	UVN -70094-015
30-2	150	45	290	50	180	13.0	UVN -70094-211
40H-1	150	30	380	50	112	10.3	UVN -70094-213
40H-2	150	45	380	50	180	14.0	UVN -70094-225
40H-3	150	55	380	60	250	18.0	UVN -70094-227
50-1	150	30	480	50	112	15.0	UVN -70094-451
50-2	150	45	480	50	180	15.8	UVN -70094-230
60-1	150	30	580	50	112	17.7	UVN -70094-233
60-2	150	45	580	50	180	18.5	UVN -70094-236

Sprocket chains.

Reversible chain with cleaner flight.

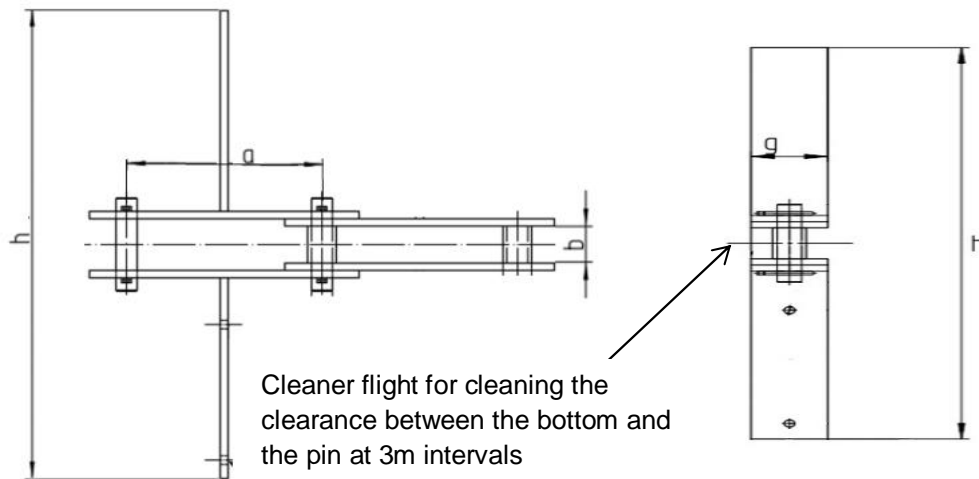
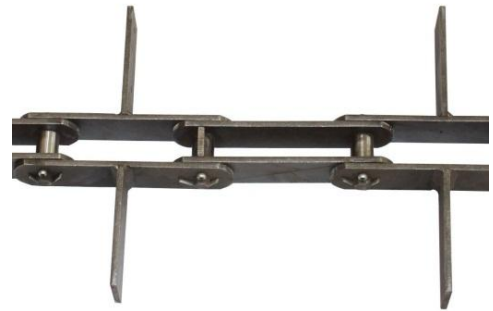

LBCA type	a [mm]	b [mm]	h [mm]	g [mm]	Breaking load [kN]	Weight [kg/m]	Article number
20	125	25	180	35	90	5.1	UVN -70094-302
30	150	30	290	50	112	9.4	UVN -70094-308
30-2	150	45	290	50	180	13.0	UVN -70094-309
40H-1	150	30	380	50	112	10.3	UVN -70094-310
40H-2	150	45	380	50	180	14.0	UVN -70094-312
40H-3	150	55	380	60	250	18.0	UVN -70094-314
50-1	150	30	480	50	112	15.0	UVN -70094-481
50-2	150	45	480	50	180	15.8	UVN -70094-483
60-1	150	30	580	50	112	17.7	UVN -70094-470
60-2	150	45	580	50	180	18.5	UVN -70094-472

Sprocket chains.

Cleaner flight.



LBCA	Cleaner flight width [mm]	Weight [kg]	Article number
20	70	0.1	LBCA-10051-001
30	125	0.1	LBCA-10043-001
30-2	110	0.1	LBCA-10067-001
40H-1	170	0.1	LBCA-10003-001
40H-2	160	0.1	LBCA-10068-001
40H-3	150	0.1	LBCA-10069-001
50-1	200	0.1	LBCA-10070-001
50-2	200	0.1	LBCA-10070-001
50-3	200	0.1	LBCA-10071-001
50-4	185	0.1	LBCA-10372-001
60-1	250	0.1	LBCA-10039-001
60-2	250	0.1	LBCA-10039-001
60-3	250	0.1	LBCA-10040-001
60-4	235	0.1	LBCA-11455-001

Material: RCH-1000 incl. bolts, nuts, and washers

Sprocket chains.

Return bucket.



LBCA	Weight [kg]	Article number
20	0.06	LBCA-10367-001
30	0.13	LBCA-10062-001
30-2	0.10	LBCA-10368-001
40H-1	0.18	LBCA-21910-001
40H-2/40H-3	0.16	LBCA-10063-001
50-1/50-2	0.21	LBCA-10076-001
50-3	0.27	LBCA-10064-001
50-4	0.32	LBCA-10370-001
60-1/60-2	0.27	LBCA-10169-001
60-3	0.35	LBCA-10041-001
60-4	0.47	LBCA-11456-001

Welded steel buckets with bolts

Sprocket chains.

Pin and bushing.



LBCA	Description	Length [mm]	Diameter [mm]	Article number
20	Pin incl. cotter pin	62	14	UVN -70094-901
	Bushing	25	20	UVN -70094-921
	Cotter pin	20	4	UNN -18010-091
30	Pin incl. cotter pin	72	16	UVN -70094-902
	Bushing	30	22	UVN -70094-922
	Cotter pin	22	5	UNN -18010-132
30-2	Pin incl. cotter pin	96.5	20	UVN -70094-905
	Bushing	45	30	UVN -70094-925
	Cotter pin	45	5	UNN -18010-135
40H-1	Pin incl. cotter pin	72	16	UVN -70094-902
	Bushing	30	22	UVN -70094-922
	Cotter pin	32	5	UNN -18010-132
40H-2	Pin incl. cotter pin	96.5	20	UVN -70094-905
	Bushing	45	30	UVN -70094-925
	Cotter pin	45	5	UNN -18010-135
40H-3	Pin incl. cotter pin	110.5	26	UVN -70094-906
	Bushing	55	36	UVN -70094-926
	Cotter pin	40	6.3	UNN -18010-151
50-1	Pin incl. cotter pin	81	16	UVN -70094-903
	Bushing	30	22	UVN -70094-923
	Cotter pin	25	5	UNN -18010-130
50-2	Pin incl. cotter pin	96.5	20	UVN -70094-905
	Bushing	45	30	UVN -70094-925
	Cotter pin	45	5	UNN -18010-135
50-3	Pin incl. cotter pin	110.5	26	UVN -70094-906
	Bushing	55	36	UVN -70094-926
	Cotter pin	40	6.3	UNN -18010-151
50-4	Pin incl. cotter pin	160	32	UVN -70094-909
	Bushing	70	44	UVN -70094-929
	Cotter pin	50	8	UNN -18010-171

Sprocket chains.

Pin and bushing.



LBCA	Description	Length [mm]	Diameter [mm]	Article number
60-1	Pin incl. cotter pin	90	16	UVN -70094-904
	Bushing	30	22	UVN -70094-924
	Cotter pin	32	5	UNN -18010-132
60-2	Pin incl. cotter pin	105	20	UVN -70094-907
	Bushing	45	30	UVN -70094-927
	Cotter pin	32	5	UNN -18010-132
60-3	Pin incl. cotter pin	129	26	UVN -70094-908
	Bushing	55	36	UVN -70094-928
	Cotter pin	40	6.3	UNN -18010-151
60-4	Pin incl. cotter pin	160	32	UVN -70094-909
	Bushing	70	44	UVN -70094-929
	Cotter pin	50	8	UNN -18010-171

Sprocket chains.

Chain sprocket and
return sprocket.



Description	Pitch circle diameter [mm]	Weight [kg]	Article number
Chain sprocket for LBCA 20			
6 teeth, 125 pitch			
Chain sprocket standard	250	12	LBCA-10050-001
Chain sprocket with hardened tooth faces and dirt groove	250	12	LBCA-26140-001
Chain sprocket with hardened tooth faces and dirt groove, split	250	12	LBCA-12645-001
Return sprocket D 50	230	9	LBCA-10049-001
Chain sprocket for LBCA 30			
7 teeth, 150 pitch			
Chain sprocket standard	346	26	LBCA-10029-001
Chain sprocket with hardened tooth faces and dirt groove	346	26	LBCA-12649-001
Chain sprocket with hardened tooth faces and dirt groove, split	346	26	LBCA-12651-001
Return sprocket D 60	324	20	LBCA-10030-001
Chain sprocket for LBCA 30-2			
7 teeth, 150 pitch			
Chain sprocket standard	346	54	LBCA-12658-001
Chain sprocket with hardened tooth faces and dirt groove	346	54	LBCA-12660-001
Chain sprocket with hardened tooth faces and dirt groove, split	346	54	LBCA-12661-001
Return sprocket D 80	324	48	LBCA-10073-001

Sprocket chains.

Chain sprocket and
return sprocket.



Description	Pitch circle diameter [mm]	Weight [kg]	Article number
Chain sprocket for LBCA 40H-1			
9 teeth, 150 pitch			
Chain sprocket standard	439	39	LAAA-12023-001
Chain sprocket with hardened tooth faces and dirt groove	439	39	LBCA-10089-001
Chain sprocket with hardened tooth faces and dirt groove, split	439	39	LBCA-10088-001
Return sprocket D 60	408	30.0	LBCA-10074-001
Chain sprocket for LBCA 40H-2			
9 teeth, 150 pitch			
Chain sprocket standard	439	72	LBCA-10024-001
Chain sprocket with hardened tooth faces and dirt groove	439	72	LBCA-12663-001
Chain sprocket with hardened tooth faces and dirt groove, split	439	72	LBCA-10087-001
Return sprocket D 80	408	48	LBCA-10073-001
Chain sprocket for LBCA 40H-3			
9 teeth, 150 pitch			
Chain sprocket standard	439	94	LBCA-10007-001
Chain sprocket with hardened tooth faces and dirt groove	439	94	LBCA-10086-001
Chain sprocket with hardened tooth faces and dirt groove, split	439	94	LBCA-27865-001
Return sprocket D 80	402	57	LBCA-10072-001

Sprocket chains.

Chain sprocket and
return sprocket.



Description	Pitch circle diameter [mm]	Weight [kg]	Article number
Chain sprocket for LBCA 50-1			
10 teeth, 150 pitch			
Chain sprocket standard	507	53	LBCA-12668-001
Chain sprocket with hardened tooth faces and dirt groove	507	53	LBCA-12671-001
Chain sprocket with hardened tooth faces and dirt groove, split	507	53	LBCA-12672-001
Return sprocket D 80	455	44	LBCA-12667-001
Chain sprocket for LBCA 50-2			
10 teeth, 150 pitch			
Chain sprocket standard	507	83	LBCA-12673-001
Chain sprocket with hardened tooth faces and dirt groove	507	83	LBCA-12676-001
Chain sprocket with hardened tooth faces and dirt groove, split	507	83	LBCA-10098-001
Return sprocket D 80	455	61	LBCA-10100-001
Chain sprocket for LBCA 50-3			
10 teeth, 150 pitch			
Chain sprocket standard	507	107	LBCA-12677-001
Chain sprocket with hardened tooth faces and dirt groove	507	107	LBCA-12679-001
Chain sprocket with hardened tooth faces and dirt groove, split	507	107	LBCA-27866-001
Return sprocket D 80	449	71	LBCA-10159-001
Chain sprocket for LBCA 50-4			
10 teeth, 150 pitch			
Chain sprocket standard	507	105	LBCA-12681-001
Chain sprocket with hardened tooth faces and dirt groove	507	105	LBCA-12683-001
Chain sprocket with hardened tooth faces and dirt groove, split	507	105	LBCA-27867-001
Return sprocket D 80	441	84	LBCA-12680-001

Sprocket chains.

Chain sprocket and
return sprocket.

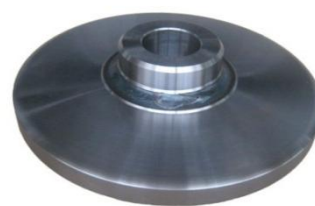

Description	Pitch circle diameter [mm]	Weight [kg]	Article number
Chain sprocket for LBCA 60-1			
10 teeth, 150 pitch			
Chain sprocket standard	507	53	LBCA-12668-001
Chain sprocket with hardened tooth faces and dirt groove	507	53	LBCA-12671-001
Chain sprocket with hardened tooth faces and dirt groove, split	507	53	LBCA-12672-001
Return sprocket D 80	455	44	LBCA-12667-001
Chain sprocket for LBCA 60-2			
10 teeth, 150 pitch			
Chain sprocket standard	507	83	LBCA-12673-001
Chain sprocket with hardened tooth faces and dirt groove	507	83	LBCA-12676-001
Chain sprocket with hardened tooth faces and dirt groove, split	507	83	LBCA-10098-001
Return sprocket D 80	455	61	LBCA-10100-001
Chain sprocket for LBCA 60-3			
10 teeth, 150 pitch			
Chain sprocket standard	507	107	LBCA-12677-001
Chain sprocket with hardened tooth faces and dirt groove	507	107	LBCA-12679-001
Chain sprocket with hardened tooth faces and dirt groove, split	507	107	LBCA-27866-001
Return sprocket D 80	449	71	LBCA-10159-001
Chain sprocket for LBCA 60-4			
10 teeth, 150 pitch			
Chain sprocket standard	507	105	LBCA-12681-001
Chain sprocket with hardened tooth faces and dirt groove	507	105	LBCA-12683-001
Chain sprocket with hardened tooth faces and dirt groove, split	507	105	LBCA-27867-001
Return sprocket D 80	441	84	LBCA-12680-001

Round-link chains.

Conveyor chain strand.

Chain link	Object	Cleaner flight width [mm]	Cleaner flight spacing [mm]	Length [m]	Weight [kg]	Article number
------------	--------	---------------------------	-----------------------------	------------	-------------	----------------

MNKA-25

Allowable tensile force [kN]: 4

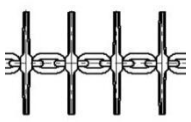
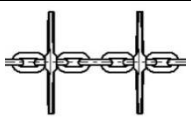
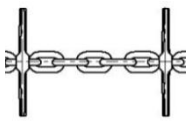
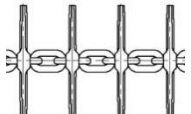
	Chain T1	172	76	10.0	31.0	MNKA-10478-001
				7.5	24.0	MNKA-10479-001
				5.0	16.0	MNKA-10480-001
				2.5	8.0	MNKA-10481-001
	Chain T2	172	152	10.0	26.0	MNKA-10482-001
				7.5	20.0	MNKA-10483-001
				5.0	13.0	MNKA-10484-001
				2.5	7.0	MNKA-10485-001
	Chain T3	172	228	10.0	24.0	MNKA-10528-001
				7.5	18.0	MNKA-10529-001
				5.0	12.0	MNKA-10530-001
				2.5	6.0	MNKA-10531-001
	Service chain	172	76	0.6	2.0	MNKA-10486-001

MNKA-50

Allowable tensile force [kN]: 16

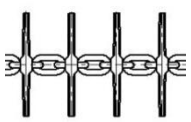
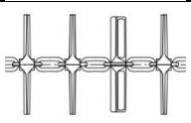
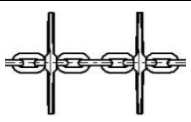
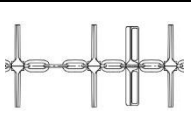
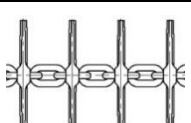
	Chain T1	225	110	10.0	29.0	MNKA-83346-820
				7.5	22.0	MNKA-83346-840
				5.0	15.0	MNKA-83346-860
				2.5	7.3	MNKA-83346-880
	Chain T1B (1 return bucket per 2m)	225	110	10.0	29.0	MNKA-83347-820
				7.5	22.0	MNKA-83347-840
				5.0	15.0	MNKA-83347-860
				2.5	7.3	MNKA-83347-880
	Chain T2	225	220	10.0	20.0	MNKA-83346-810
				7.5	15.0	MNKA-83346-830
				5.0	10.0	MNKA-83346-850
				2.5	5.0	MNKA-83346-870
	Chain T2B (1 return bucket per 2m)	225	220	10.0	21.0	MNKA-83347-810
				7.5	16.0	MNKA-83347-830
				5.0	11.0	MNKA-83347-850
				2.5	5.3	MNKA-83347-870
	Service chain	225	110	0.5	1.4	MNKA-84364-810

Round-link chains.

Conveyor chain strand.

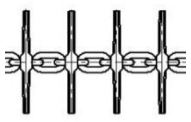
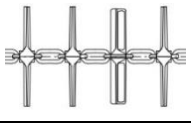
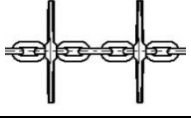
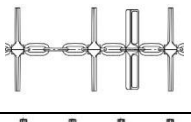
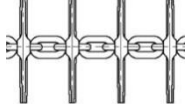
Chain link	Object	Cleaner flight width [mm]	Cleaner flight spacing [mm]	Length [m]	Weight [kg]	Article number
MNKA-100						
Allowable tensile force [kN]: 25						
	Chain T1	300	140	10.0	50.0	MNKA-83205-820
				7.5	37.5	MNKA-83205-840
				5.0	25.0	MNKA-83205-860
				2.5	12.5	MNKA-83205-880
	Chain T1B (1 return bucket per 2m)	300	140	10.0	50.0	MNKA-83204-820
				7.5	37.5	MNKA-83204-840
				5.0	25.0	MNKA-83204-860
				2.5	12.5	MNKA-83204-880
	Chain T2	300	280	10.0	40.0	MNKA-83205-810
				7.5	30.0	MNKA-83205-830
				5.0	20.0	MNKA-83205-850
				2.5	10.0	MNKA-83205-870
	Chain T2B (1 return bucket per 2m)	300	280	10.0	41.0	MNKA-83204-810
				7.5	31.0	MNKA-83204-830
				5.0	20.5	MNKA-83204-850
				2.5	10.3	MNKA-83204-870
	Service chain	300	140	0.6	2.8	MNKA-84365-810

Round-link chains.

Conveyor chain strand.

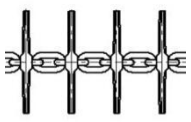
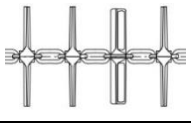
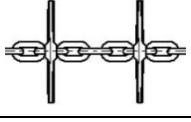
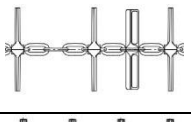
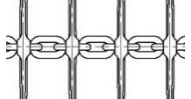
Chain link	Object	Cleaner flight width [mm]	Cleaner flight spacing [mm]	Length [m]	Weight [kg]	Article number
MNKA-200						
Allowable tensile force [kN]: 25						
	Chain T1	384	140	10.0	54.0	MNKA-83202-820
				7.5	40.5	MNKA-83202-840
				5.0	27.0	MNKA-83202-860
				2.5	13.5	MNKA-83202-880
	Chain T1B (1 return bucket per 2m)	384	140	10.0	54.0	MNKA-83201-820
				7.5	40.5	MNKA-83201-840
				5.0	27.0	MNKA-83201-860
				2.5	13.5	MNKA-83201-880
	Chain T2	384	280	10.0	42.0	MNKA-83202-810
				7.5	31.5	MNKA-83202-830
				5.0	21.0	MNKA-83202-850
				2.5	10.5	MNKA-83202-870
	Chain T2B (1 return bucket per 2m)	384	280	10.0	43.0	MNKA-83201-810
				7.5	32.5	MNKA-83201-830
				5.0	21.5	MNKA-83201-850
				2.5	10.8	MNKA-83201-870
	Service chain	384	140	0.6	3.0	MNKA-84366-810

Material: case-hardened steel chain with plastic flights

Round-link chains.

Cleaner flight and
Conveyor flight.

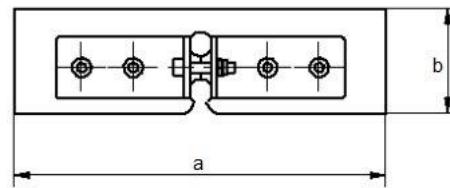

MNKA type	Object	a [mm]	b [mm]	Weight [kg]	Article number
25	Cleaner flight	180	51	0.3	MNKA-10565-001
	Conveyor flight	172	45	0.3	MNKA-10573-001
50	Cleaner flight	240	48	0.5	MNKA-84451-810
	Conveyor flight	225	45	0.5	MNKA-84341-810
100	Cleaner flight	315	57	0.6	MNKA-81010-810
	Conveyor flight	300	55	0.6	MNKA-84202-810
200	Cleaner flight	400	57	0.8	MNKA-81011-810
	Conveyor flight	384	55	0.7	MNKA-84201-810

Type 25 plastic flights, from type 50 plastic flights with steel cores

Return buckets.

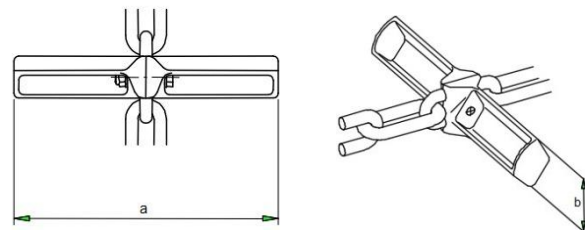

MNKA type	Object	a [mm]	b [mm]	Weight [kg]	Article number
50	Return bucket	215	45	0.4	MNKA-84342-810
100	Return bucket	290	55	0.5	MNKA-84317-810
200	Return bucket	290	55	0.5	

Round-link chains.

Closing links.



MNKA type	Object	Weight [kg]	Article number
25	Closing link	0.1	MNKA-10487-001
50	Closing link	0.1	MNKA-50032-010
100	Closing link	0.2	MNKA-50011-010
200			

Drive and return sprockets.



MNKA type	Object	Pitch circle diameter [mm]	Weight [kg]	Article number
25	Return sprocket	75	1.2	MNKA-10443-001
	Drive sprocket			
50	Return sprocket	120	2.9	MNKA-83506-810
	Drive sprocket	120	2.9	MNKA-83505-810
100	Return sprocket	150	6.5	MNKA-82429-810
	Drive sprocket	150	7.0	MNKA-82424-810
200	Return sprocket	220	16.8	MNKA-82430-810
	Drive sprocket	220	16.5	MNKA-82428-810

Scope of supply: tooth segments, anvil segments, bolts, and nuts

The Bühler Conveyor Chain Catalog shows the most common chains and their accessories. Additional chain types or options are available upon request. The Grain Logistics Service Function would be pleased to assist you.



Grain Logistics Service Function, Germany
Phone +49 8461 701 701
service.gl@buhlergroup.com

Bühler GmbH
Grain Logistics
DE-92339 Beilngries, Germany
T +49 8461 701 0
F +49 8461 701 133
grain-logistics@buhlergroup.com
www.buhlergroup.com

